

Snap Action Switches

Technical Information

Glossary

General Terms

Basic Switch (Snap Action Switch)	A small-size switch which has contacts slightly separated and a snap action mechanism. Its contacts are enclosed in a case and operated by externally applying a specific force to an actuator provided on the case.
Contact Form	A configuration of switch contacts to input or output an external signal.
Switch with Contacts	A type of switch which uses, as opposed to a solid-state switch, mechanical contacts to break or make the external circuit.
Ratings	Various parameters, such as current or voltage values, within which the normal operation of the basic switch is guaranteed.
Molded Terminal	A terminal which is molded with resin after being connected to the internal circuit of the switch with a lead to eliminate exposed current-carrying metal parts and thereby to enhance the drip-proof properties of the switch.
Insulation Resistance	The resistance between discontinuous terminals, between terminals and non-current-carrying metal parts, and between terminals and ground.
Dielectric Strength	The threshold value up to which insulation will not be destroyed when a high voltage is applied for 1 minute to a predetermined measurement location.
Contact Resistance	The electrical resistance of the contact point of contacts. Generally, the contact resistance includes the conductive resistance of the spring or terminal section
Vibration Resistance	Malfunction: The range of vibration for which closed contacts will not open for longer than a specific time when vibration is applied to a switch currently in operation.
Shock Resistance	Destruction: The range of shock for which the components of the switch will not be damaged and for which operating characteristics are maintained when mechanical shock is applied to a switch during transportation or installation. Malfunction: The range of shock for which closed contacts will not open for longer than a specific time when shock is applied to a switch currently in operation.

Terms for Configuration & Structure

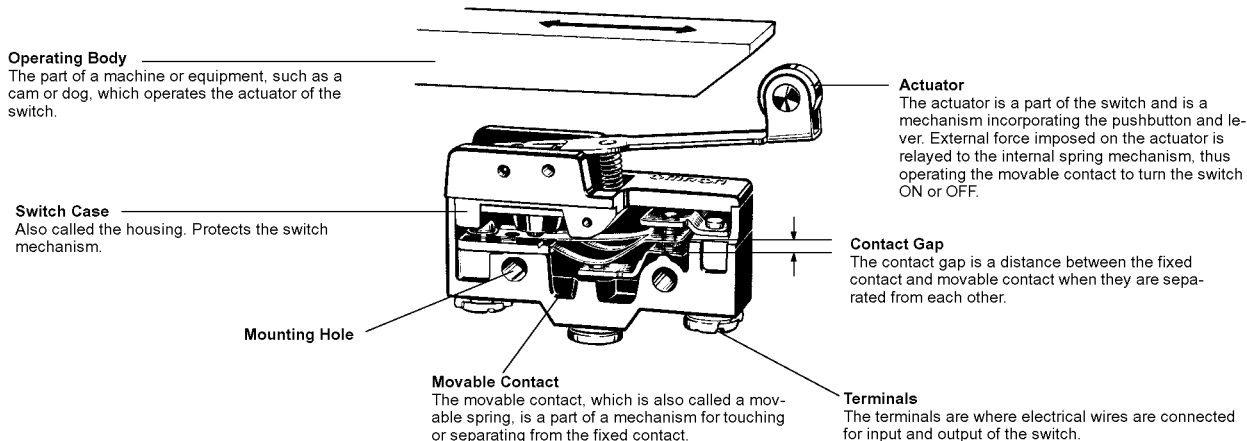

Terms Related to Life Expectancy

Mechanical Service Life	The duration in which the normal switching operation is performed without the contacts energized as long as the switch is used with the rated overtravel (OT).
Electrical Service Life	The duration in which the normal switching operation is performed under the rated load (resistive) as long as the switch is used with the rated overtravel (OT).

Life Expectancy is also commonly referred to as "Durability".

Standard Test Conditions

Switches are tested under the following conditions;

- Ambient temperature 20±2°C
- Relative humidity: 65±5%
- Atmospheric pressure: 101.3 kPa



N-level Reference Value

The N-level reference value indicates the failure rate of the switch.

The following formula indicates that the failure rate is 1/2,000,000 at a reliability level of 60% (λ_{60}).

$$\lambda_{60} = 0.5 \times 10^{-6} / \text{operations}$$

■ Contact Shape and Type

Shape	Type	Main Material	Processing Method	Main Application
	Crossbar contact	Gold or silver alloy	Welding or riveting	Crossbar contacts are used for ensuring high contact reliability for switching micro loads. The movable contact and fixed contact come in contact with each other at a right angle. Crossbar contacts are made with materials that are environment-resistant, such as gold alloy. In order to ensure excellent contact reliability, bifurcated crossbar contacts may be used.
	Needle	Silver		Needle contacts are used for ensuring improvement in contact reliability for switching loads, such as relays. A needle contact is made from a rivet contact by reducing the bending radius of the rivet contact to approximately 1 mm for the purpose of improving the contact pressure per unit area.
	Rivet	Silver Silver plated Silver alloy Gold plated		Rivet contacts are used in a wide application range from standard to heavy loads. The fixed rivet contact is usually processed so that it has a groove to eliminate compounds that may be generated as a result of switching. Furthermore, to prevent the oxidation or sulphuration of the silver contacts while the switch is stored, the contacts may be gold-plated. Contacts made with silver alloy are used for switching high current, such as the current supplied to TV sets.

■ Contact Gap

The contact gap is either 0.25, 0.5, 1.0, or 1.8 mm. Check the contact gap of the switch to be used if a minimum contact gap is required. The standard contact gap is 0.5 mm. The smaller the contact gap of a switch mechanism is, the less the movement differential (MD) is and the more sensitivity and longer life the switch has. Such a switch cannot ensure, however, excellent switching performance, vibration resistance, or shock resistance.

A switch becomes less sensitive when the movement differential (MD) increases along with the contact gap due to the wear and tear of the contacts as a result of current switching operations. If a switch with a contact gap of 0.25mm is used for its high sensitivity, it will be necessary to minimize the switching current in order to prevent the wear and tear of the contacts as a result of current switching operations. A switch with a wide contact gap excels in vibration resistance, shock resistance, and switching performance.

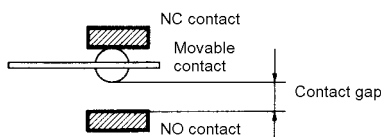

Character displayed	Contact gap	DC switching	MD	Accuracy and life expectancy	Vibration and shock resistance	Feature
H	0.25 mm	Inferior	Minimal	Excellent	Inferior	High precision and long life
G	0.50 mm	Ordinary	Short	Good	Ordinary	General-purpose
F	1.00 mm	Good	Medium	Ordinary	Good	Performance level between G & E
E	1.80 mm	Excellent	Long	Inferior	Excellent	Highly vibration & shock resistive

■ Terms Related to Operating Characteristics

Definitions of Operating Characteristics	Classification	Term	Abbreviation	Unit	Dispersion	Definition
	Force	Operating Force	OF	N{gf, kgf}	Max.	The force applied to the actuator required to operate the switch contacts from the Free Position to the Operating Position.
		Releasing Force	RF	N{gf, kgf}	Min.	The value to which the force on the actuator must be reduced to allow the contacts to return to the Free Position.
		Total Travel Force	TTF	N{gf, kgf}	—	The force required for the actuator to reach the Total Travel Position from the Free Position.
	Travel	Pretravel	PT	mm or degrees	Max.	The distance or angle through which the actuator moves from the Free Position to the Operating Position.
		Overtravel	OT	mm or degrees	Min.	The distance or angle of the actuator movement beyond the operating position to the Total Travel Position.
		Movement Differential	MD	mm or degrees	Max.	The distance or angle from the Operating Position to the Releasing Position.
		Total Travel	TT	mm or degrees	—	The distance or angle of the actuator movement from the Free Position to the Total Travel Position. (The sum of the Pretravel and Total overtravel expressed as a distance or angle.)
	Position	Free Position	FP	mm or degrees	Max.	The initial position of the actuator when no external force is applied.
		Operating Position	OP	mm or degrees	±	The position of the actuator at which the contacts snap to the operated contact position.
		Releasing Position	RP	mm or degrees	—	The position of the actuator at which the contacts snap from the operated contact position to their Free Position.
		Total Travel Position	TTP	mm or degrees	—	The position of the actuator when it reaches the stopper.

Example of Fluctuation:

V-21-1□6 with max. operating force of 3.92 N {400 gf}

The above means that each switch sample operates with a maximum operating force (OF) of 3.92 N when increasing the OF imposed on the actuator from 0.

■ Terminal Symbol and Contact Form

Contact	Terminal symbol
COM	Common terminal
NC	Normally closed terminal
NO	Normally open terminal

■ Terminal Types

Type	Shape
Solder terminal	
Quick-connect (#110, 187, and 250)	
Screw terminal	
PCB terminal	
PCB angle terminal	

Note: In addition to the above, molded terminals with lead wires and snap-on mounting connectors are available.

■ Contact Form

Symbol	Name	Model example
	SPDT	Standard snap-action switch
	SPST-NC	V
	SPST-NO	V
	Split-contact type	Z-10FY-B
	Maintained-contact type	Z-15ER
	DPDT	DZ

Note: The above illustrations show typical examples. For the contact form of each product, refer to the individual datasheets.

■ Terms Related to EN61058-1 Standards

Electric Shock Protective Class: Indicates the electric shock preventive level. The following classes are provided.

- Class 0: Electric shocks are prevented by basic insulation only.
- Class I: Electric shocks are prevented by basic insulation and grounding.
- Class II: Electric shocks are prevented by double insulation or enforced insulation with no grounding required.
- Class III: No countermeasures against electric shocks are required because the electric circuits in use operate in a low-enough voltage range (50 VAC max. or 70 VDC max.)

Proof Tracking Index (PTI): Indicates the index of tracking resistance, that is, the maximum dielectric strength with no short-circuiting between two electrodes attached to the switch sample while 50 drops of 0.1% ammonium chloride solution are dropped between the electrodes drop by drop. Five levels are provided. The following table indicates the relationship between these PTI levels and CTI values according to the UL Plastics Recognized Directory.

PTI	CTI Classified by UL
500	PLC level 1: $400 \leq CTI < 600$ (Check with material manufacturer if the material meets CTI 500)
375	PLC level 2: $250 \leq CTI < 400$ (Check with material manufacturer if the material meets CTI 375)
300	PLC level 2: $250 \leq CTI < 400$ (Check with material manufacturer if the material meets CTI 300)
250	PLC level 2: $250 \leq CTI < 400$
175	PLC level 3: $175 \leq CTI < 250$

Number of Operations: Indicates the operation number of durability test provided by the standard. They are classified into the following levels and the switch must bear the corresponding symbol. A switch with high switching frequency must withstand 50,000 switching operations and that with low switching frequency must withstand 10,000 operations to satisfy IEC standards.

Number of Operations	Symbol
100,000	1E5
50,000	5E4
25,000	25E3
10,000	No symbol required
6,000	6E3
3,000	3E3
1,000	1E3
300	3E2

Ambient Temperature: Indicates the operating temperature range of the switch. If the temperature range is not between 0°C and 55°C, the switch must bear the symbol of the temperature range. Refer to the following example.

Symbol	T85	25T85
Temperature range	0°C to 85°C	-25°C to 85°C

Solder Terminal Type 1: A type of solder terminal classified by heat resistance under the following test conditions.

Dip soldering bath applied: The terminal must not wobble or make any change in insulation distance after the terminal is dipped for a specified depth and period into a dip soldering bath at a temperature of 235°C at specified speed.

Soldering iron applied: The terminal must not wobble or make any change in insulation distance after the terminal is soldered by applying wire solder that is 0.8mm in diameter for two to three seconds by using a soldering iron, the tip temperature of which is 350°C.

Solder Terminal Type 2: A type of solder terminal classified by heat resistance under the following test conditions.

Dip soldering bath applied: The terminal must not wobble or make any change in insulation distance after the terminal is dipped for a specified depth and period into a dip soldering bath at a temperature of 260°C at specified speed.

Soldering iron applied: The terminal must not wobble or make any change in insulation distance after the terminal is soldered by applying wire solder that is 0.8 mm in diameter for 5 seconds by using a soldering iron, the tip temperature of which is 350°C.

Clearance distance: The minimum space distance between two charged parts or between a charged part and a metal foil stuck to the non-metal switch housing.

Creepage distance: The minimum distance on the surface of the insulator between two charged parts or between a charged part and a metal foil stuck to the non-metal switch housing.

Distance through insulation: The minimum direct distance between the charged part and a metal foil stuck to the non-metal switch housing through air plus any other insulator thickness including the housing itself. The distance through insulation will be the insulator thickness when there is no distance through air.

Cautions

General Precautions

Mounting

Before mounting, dismantling, wiring, or inspecting the Switch, be sure to turn OFF the power supply to the Switch, otherwise an electric shock may be received or the Switch may burn.

When mounting the Switch to the mounting panel, keep a sufficient insulation distance between the mounting panel and the Switch. If the insulation distance is insufficient, add an appropriate insulation guard or separator. This is especially important if the Switch is mounted to a metal object.

Wiring

Do not wire the Switch or touch any terminal of the Switch while power is connected to the Switch, otherwise an electric shock may be received. The Basic Switch does not incorporate a ground terminal. Do not mount the Basic Switch while power is being supplied.

Follow the instructions provided in *Correct Use* for all wiring and soldering work. Using a switch with improper wiring or soldering may result in abnormal heating when power is supplied, possibly resulting in burning.

Contact Load

Select suitable switch ratings after confirming contact load. If the contact load is excessive for the contacts, the contacts may weld or shift, possibly resulting in short-circuits or burning when power is supplied.

Load Type

Some types of load have a large difference between steady-state current and inrush current. Make sure that the inrush current is within the permissible value. The higher the inrush current in the closed circuit is, the more the contact abrasion or shift will be. Consequently, contact weld, contact separation failures, or insulation failures may result. Furthermore, the Switch may break or become damaged.

Types of Load vs. Inrush Current

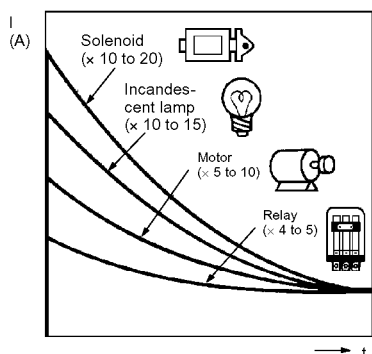

The switching capacity of each Switch appearing on a datasheet is the rated capacity. When applying the Switch to a circuit with a special load with unusual inrush and switching current and voltage waveforms, be sure to test the Switch under the actual conditions before use.

If the load is a micro voltage or current load, use a dedicated Switch for micro loads. The reliability of silver-plated contacts, which are used by standard Switch models, is insufficient in such a case.

Operating Atmosphere

Do not use switches in atmospheres containing combustible or explosive gases. Arc or heat generated by switching may cause fires or explosions.

Shock on Individual Switches

Do not drop or disassemble switches. Not only will characteristics be jeopardized, but also damage, electric shock, or burning may result.

Life Expectancy

The life of the Switch greatly varies with switching conditions. Before using the Switch, be sure to test the Switch under actual conditions. Make sure that the number of switching operations is within the permissible range. If a deteriorated Switch is used continuously, insulation failures, contact weld, contact failures, Switch damage, or Switch burnout may result.

Load Connections

Example of Power Source Connection (Different Polarity)

The power source may short-circuit in failure mode if the loads are connected in the same way as the "incorrect" circuit below.

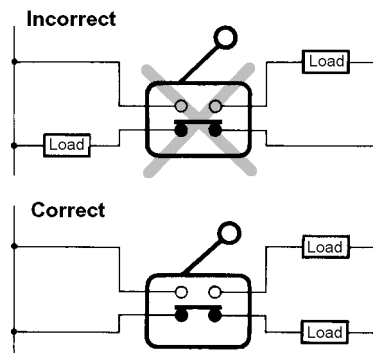

Connect the same polarities to the load.

Even in a "correct" circuit, note that the insulation performance of the switch may deteriorate and the switch life may be shortened because one load is connected to one contact.

Example of Incorrect Connection of Power Source (Different Current Type)

The DC and AC power may be mixed.

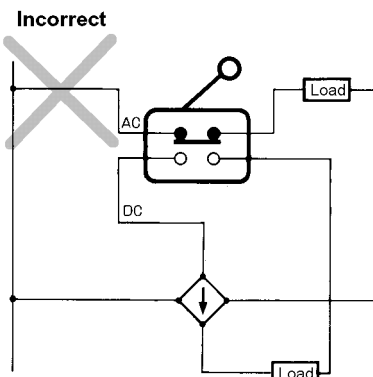

Do not configure a circuit that may place a voltage between the contacts of the Switch; otherwise metal deposition will occur between the contacts.

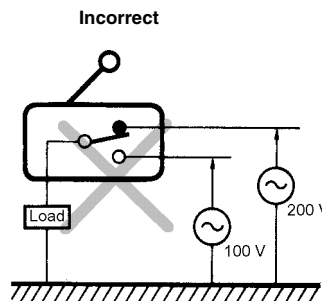

Correct Use

■ Using Switches

When Switches are actually used, unforeseen accidents may occur. Before using a switch, perform all possible testing in advance.

Unless otherwise specified, ratings and performances given in this catalog are for standard test conditions (i.e., 15 to 35°C, 25% to 75% humidity, and 86 to 106 kPa atmospheric pressure). When performing testing in the actual application, always use the same conditions as will be used in actual usage conditions for both the load and the operating environment.

Reference data provided in this catalog represents actual measurements from production samples in graph form. All reference data values are nominal.

All ratings and performance values provided in this catalog are the results of a single test. Each rating and performance value therefore may not be met for composite conditions.

■ Selecting Correct Switches

Select an appropriate switch for the operating environment and load conditions.

Switches for Micro Loads

Use a dedicated Switch for micro loads, otherwise contact failures may result. Be sure to connect the Switch to a load within the permissible range. Even if the load is within the permissible range, the inrush current of the load may deteriorate the contacts, thus shortening the life of the Switch. Therefore, if necessary, insert the proper contact protective circuit.

- It is not recommended to use a switch for a large current to switch a micro current, in terms of contact reliability. Select a switch that is suitable for the current actually being switched.
- Use a sealed switch in environments subject to water, other liquids and excessive dirt or dust.

■ Electrical Conditions

Load

The switching capacity of the Switch significantly differs depending on whether the Switch is used to break an alternating current or a direct current. Be sure to check both the AC and DC ratings of the Switch by referring to its datasheet. The control capacity will drop drastically if it is a DC load. This is because a DC load, unlike an AC load, has no current zero cross point. Therefore, if an arc is generated, it may continue for a comparatively long time. Furthermore, the current direction is always the same, which results in contact relocation phenomena, and the contacts hold each other with ease and will not separate if the surfaces of the contacts are uneven.

If the load is inductive, counter-electromotive voltage will be generated. The higher the voltage is, the higher the generated energy is, which increase the abrasion of the contacts and contact relocation phenomena. Make sure to use the Switch within the rated conditions.

If the Switch is used for switching both minute and heavy loads, be sure to connect relays suitable to the loads.

The rated loads of the Switch are as follows:

- Inductive Load:** A load having a minimum power factor of 0.4 (AC) or a maximum time constant of 7 ms (DC).
- Lamp Load:** A load having an inrush current ten times the steady-state current.
- Motor Load:** A load having an inrush current six times the steady-state current.

Note: It is important to know the time constant (L/R) of an inductive load in a DC circuit.

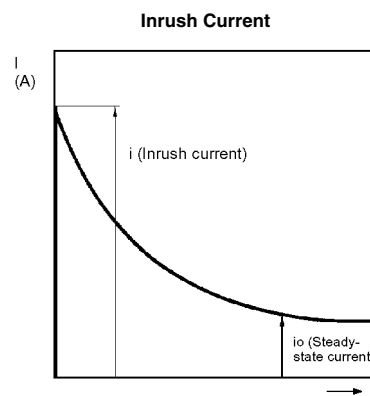

Application of Switch to Electronic Circuits

The Basic Switch in switching operation may cause contact bouncing or chattering, thus generating noise or pulse signals that may interfere the operation of electronic circuits or audio equipment. To prevent this, take the following countermeasures.

- Design the circuits so that they include appropriate CR circuits to absorb noise or pulse signals.
- Use Switches incorporating gold-plated contacts for minute loads, which are more resistive to environmental conditions than standard Switches.

Contact Protective Circuit

Apply a contact protective circuit to extend contact life, prevent noise, and suppress the generation of carbide or nitric acid. Be sure to apply the contact protective circuit properly, otherwise an adverse effect may result. The use of the contact protective circuit may delay the response time of the load.

The following provides typical examples of contact protective circuits. If the Switch is used in an excessively humid place for switching a load that generates arcs with ease, such as an inductive load, the arcs may generate nitrous oxides, which will change into HNO₃ (nitric acid) if it reacts with moisture. Consequently, the internal metal part may be corroded and result in an operating failure of the Switch. Be sure to select the best contact preventive circuit from the following in order to prevent this.

Typical Examples of Contact Protective Circuit

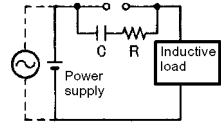
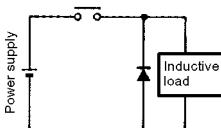
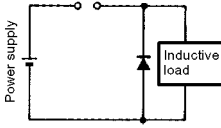
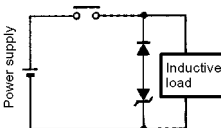
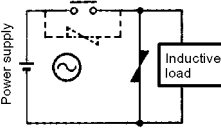
Circuit example	Applicable current		Feature	Element selection
	AC	DC		
	See note	Yes	Note: When AC is switched, the load impedance must be lower than the CR impedance.	C: 0.5 to 1 μF per switching current (1 A) R: 0.5 to 1 Ω per switching voltage (1 V) The values may change according to the characteristics of the load. The capacitor suppresses the spark discharge of current when the contacts are open. The resistor limits the inrush current when the contacts are closed again. Consider these roles of the capacitor and resistor and determine the ideal capacitance and resistance values from experimentation. Use a capacitor that has low dielectric strength. When AC is switched, make sure that the capacitor has no polarity. If, however, the ability to control arcs between contacts is a problem for high DC voltage, it may be more effective to connect a capacitor and resistor between the contacts across the load. Check the results by testing in the actual application.
		Yes		
	No	Yes	Energy stored in the coil is changed into current by the diode connected in parallel to the load. Then the current flowing to the coil is consumed and Joule heat is generated by the resistance of the inductive load. The reset time delay in this method is longer than that of the CR method.	The diode must withstand a peak inverse voltage 10 times higher than the circuit voltage and a forward current as high as or higher than the load current.
	No	Yes	This method will be effective if the reset time delay caused by the diode method is too long.	Zener voltage for a Zener diode must be about 1.2 times higher than the power source since the load may not work under some circumstances.
	Yes	Yes	This method makes use of constant-voltage characteristic of the varistor so that no high-voltage is imposed on the contacts. This method causes a reset time delay more or less. It is effective to connect varistor in parallel to the load when the supply voltage is 24 to 48 V and in parallel to the contacts when the supply voltage is 100 to 200V.	Select the varistor so that the following condition is met for the cut voltage V _C . For AC currents, the value must be multiplied by $\sqrt{2}$. $V_C > (\text{Current Voltage} \times 1.5)$ If V _C is set too high, however, the voltage cut for high voltages will no longer be effective, diminishing the effect.

Do not apply contact protective circuits as shown below.

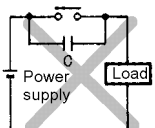
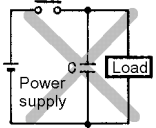
	This circuit effectively suppresses arcs when the contacts are OFF. The capacitance will be charged, however, when the contacts are OFF. Consequently, when the contacts are ON again, short-circuited current from the capacitance may cause contact weld.		This circuit effectively suppresses arcs when the contacts are OFF. When the contacts are ON again, however, charge current flows to the capacitor, which may result in contact weld.
---	---	--	---

Mechanical Conditions

Operating Stroke Setting

The setting of the stroke is very important for the Switch to operate with high reliability.

The chart below shows the relationship among operating force, stroke, and contact reliability. To obtain high reliability from the Switch, the Switch actuator must be manipulated within an appropriate range of operating force.

Be sure to pay the utmost attention when mounting the Switch.

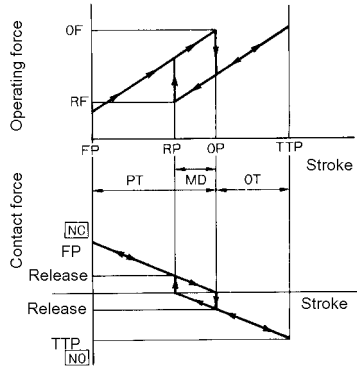

Make sure that operating body returns the actuator to the free position when the operating body has moved if the Switch is used to form a normally closed (NC) circuit. If the Switch is used to form a normally open (NO) circuit, the operating body must move the Switch actuator to a distance of 70% to 100% of the rated overtravel (OT) of the Switch.

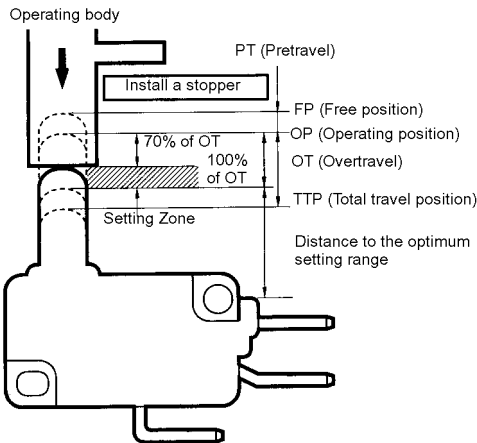

If the stroke is set in the vicinity of the operating position (OP) or at the releasing position (RP), switching operation may become unstable. As a result, the Switch cannot ensure high reliability. Furthermore, the Switch may malfunction due to vibration or shock.

If the stroke is at the total travel position (TTP), the momentary inertia of the operating body may damage the actuator or the Switch itself. Furthermore, the life of the Switch may be shortened.

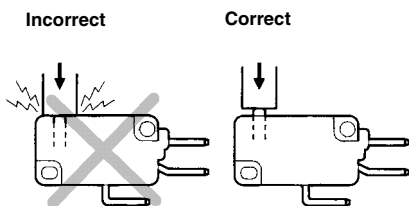

Switching Speed and Frequency

The switching frequency and speed of a Switch have a great influence on the performance of the Switch. Pay attention to the following.

- If the actuator is operated too slowly, the switching operation may become unstable, causing faulty contact or contact weld.
- If the actuator is operated too quickly, the Switch may be damaged by shock.
- If the switching frequency is too high, the switching of the contacts cannot catch up with the operating speed of the actuator.
- If the operating frequency is extremely low (i.e., once a month or less frequent), a film may be generated on the surface of the contacts, which may cause contact failures.

The permissible switching speed and switching frequency of a Switch indicates the operational reliability of the Switch. The life of the Switch may vary with the switching speed if the Switch is operated within the permissible switching speed and frequency ranges. Test a Switch sample under the actual conditions to ascertain its life expectancy.

Operating Condition

Do not leave the Switch actuated for a long time, otherwise the parts of the Switch may soon deteriorate and changes in its characteristic performance may result.

Switching Method

The switching method has a great influence on the performance of the Switch. Consider the following before operating the Switch.

- Design the operating body (i.e., the cam or dog) so that it will operate the actuator smoothly. If the actuator snaps backwards quickly or receives damage due to the shape of the operating body, its life expectancy may be shortened.

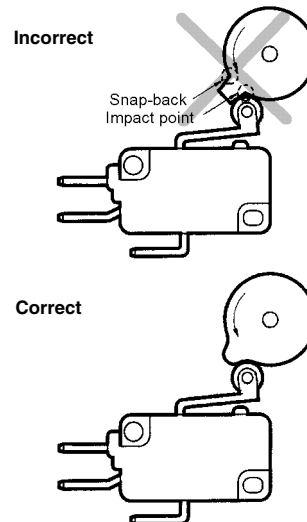

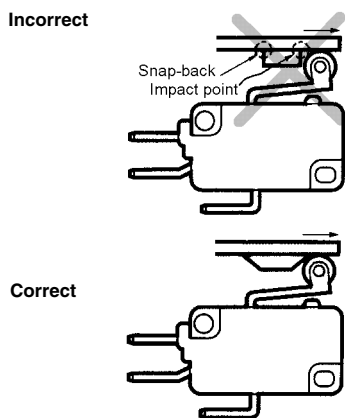

- Make sure that no improper load is imposed on the actuator, otherwise the actuator may incur local abrasion. As a result, the actuator may become damaged or its life expectancy shortened.

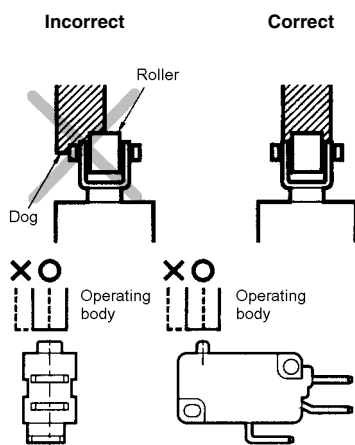

- Make sure that the operating body moves in a direction where the actuator moves. If the actuator is a pin plunger type, make sure that the operating body presses the pin plunger vertically.

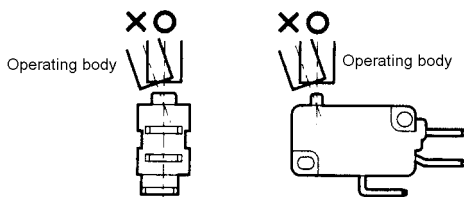

- Operate the actuator of a roller hinge lever or simulated hinge lever type in the direction shown below. Set the angle of the cam or dog (θ) for roller levers and similar actuators to the range of 30° and 45°. If the angle is too large, an abnormally large horizontal stress will be applied to the lever.

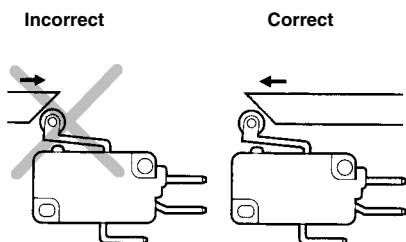

- Do not modify the actuator to change the operating position (OP) If the actuator is modified, excessive external force may be applied to the internal switch mechanism, characteristics may change and the switch may stop functioning.
- If an external actuator is used as an operating object, check the material and thickness of the lever and make sure that the force imposed on the lever is within the permissible range.

■ Mounting

When mounting the Switch, pay attention to the following.

Securing

When mounting the Switch, be sure to use the specified mounting screws and tighten the screws with flat washers and spring washers securely.

However, the Switch housing may incur crack damage if it comes into contact with the spring washers directly. In that case make sure that the flat washers come into contact with the Switch housing as shown below. Do not subject the switch to excessive shock or high-frequency vibrations when mounting (e.g., do not use an impact driver) as it may cause contact stick or switch damage.

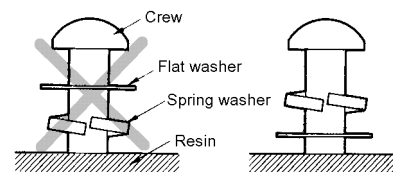

- Do not modify the Switch in any way, for example, by widening the mounting holes

Locking Agent

If glue or locking agent is applied, make sure that it does not stick to the movable parts or intrude into the interior of the Switch, otherwise the Switch may work improperly or cause contact failure. Some types of glue or locking agent may generate gas that has a bad influence on the Switch. Pay the utmost attention when selecting the glue or locking agent.

Wiring

Make sure that the lead wires are connected with no inappropriate pulling force and that the wires are supported securely.

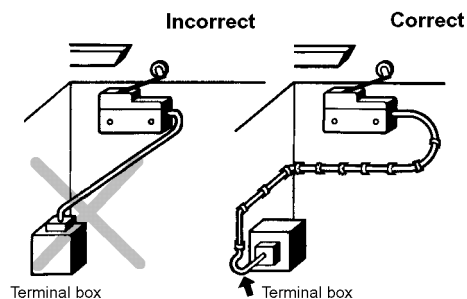

Mounting Location

Be sure not to mount the Switch in locations where the Switch may be actuated by mistake.

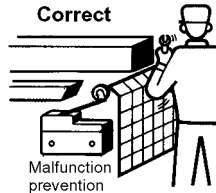
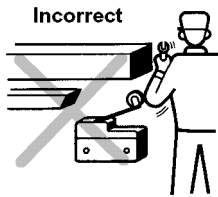

Maintenance and Inspection

Make sure that the Switch is mounted in locations that allow easy inspection or replacement of the Switch.

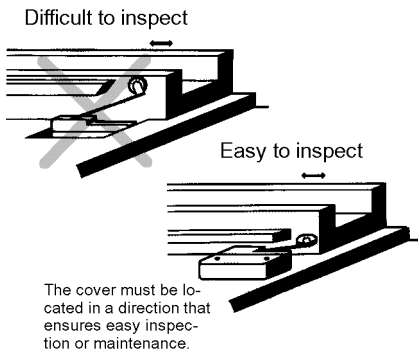

Mounting Direction

When using a Switch of low operating force attached with a long lever or long rod lever, make sure that the lever is in the downward direction as shown below, otherwise the Switch may not reset properly.

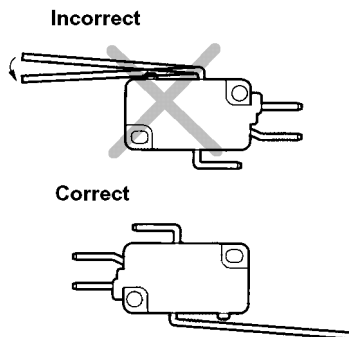

Terminal Connections

Solder Terminals

When soldering lead wires to a switch, make sure that the temperature of the iron tip is 380°C maximum. Improper soldering may cause abnormal heat radiation from the switch and the switch may burn.

Complete soldering within 5 seconds at 350°C or within 3 seconds at 380°C. If heat is applied for longer period of time, switch characteristics will be deteriorated, e.g., the case will melt and lead wire insulation will scorch.

Soldering conditions are even more strict for ultra subminiature switches. Refer to the *Precautions* for individual models for details.

Quick-Connect Terminals

Use the specified receptacles to connect to quick-connect terminals. Do not apply excessive force horizontally or vertically to the terminals, otherwise the terminal may be deformed or the housing may be damaged.

Wiring Work

When wiring a switch, check the insulation distance between the switch and the mounting plate. If the insulation distance is insufficient, use an insulation guard or separator. Be particularly careful when mounting a switch to metal.

Use wire sizes suitable for the applied voltage and carrying current.

Do not wire a switch while power is being supplied.

Using Separators

If providing sufficient insulation distance is a problem or there are metal components or copper wire near a switch, use a switch with an insulation guard or use a separator (order separately) to provide sufficient insulation distance.

Separator for SS□

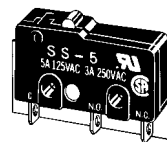

Separator

Separator for V□

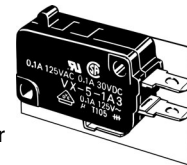

Separator

Separator for Z□

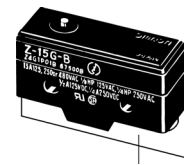

Separator

Soldering Precautions

When soldering by hand, place the terminal horizontal to the ground, use a soldering iron with a suitable heat capacity and a suitable amount of solder, and complete soldering quickly. Prevent flux from entering a switch by exhausting flux gas with an exhaust fan and by avoiding the contact of the tip of the soldering iron and the switch body. Flux gas inside a switch may cause contact failure. Do not apply any force to the terminal or wire immediately after soldering.

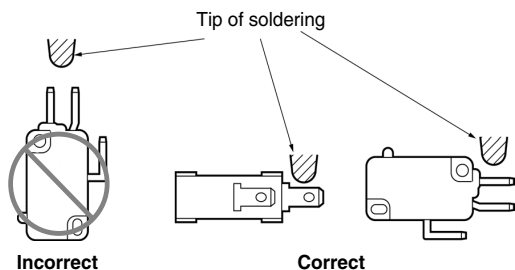

When soldering automatically, adjust the amount of solder so that flux does not float onto the top of PCB. If flux enters the switch, it can cause contact failure.

Operation and Storage

Oil and Water Resistance

The standard Switch is not water-resistant. Protect the Switch appropriately when using the Switch in places with water or oil spray. If the Switch is exposed to water drops, use a sealed Switch.

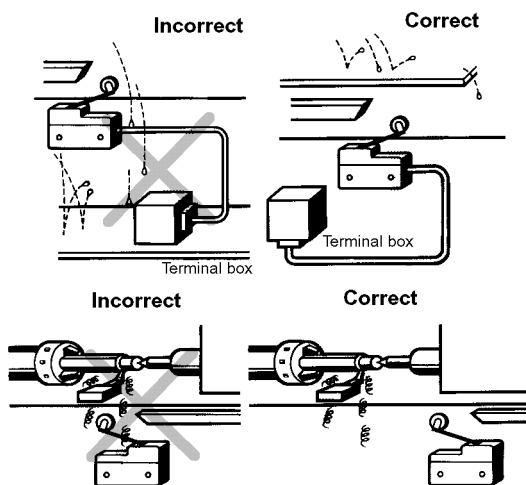

Operating Environment

Do not install the Switch in any location or direction where the Switch resonates or continuous vibration or shock is imposed on the Switch. If continuous vibration or shock is imposed on the Switch, a contact failure, malfunction, or a decrease in life expectancy may be caused by abrasive powder generated from the internal parts. If excessive vibration or shock is imposed on the Switch, the contacts may malfunction or become damaged.

A general switch is not water-resistant. Protect the switch appropriately when using the switch in places with water or oil spray.

Do not use the Switch in locations with corrosive gas, such as sulfuric gas (H_2S or SO_2), ammonium gas (NH_3), nitric gas (HNO_3), or chlorine gas (Cl_2), or in locations with high temperature and humidity. Otherwise, contact failure or corrosion damage may result.

If the Switch is used in places with silicone gas, arc energy may attract silicon dioxide (SiO_2) to the contacts and a contact failure may result. If there is silicone oil, silicone sealant, a wire covered with silicone, or any other silicone-based product near the Switch, attach a

contact protective circuit to suppress the arcing of the Switch or eliminate the source of silicone gas generation. Even for a sealed switch, it may not be possible to prevent all of the gas from penetrating the seal rubber, and contact failure may result.

Be sure to use the Switch at temperature and humidity within the specified ranges. If the Switch is exposed to radical temperature changes or intense heat, the performance characteristics of the Switch may change.

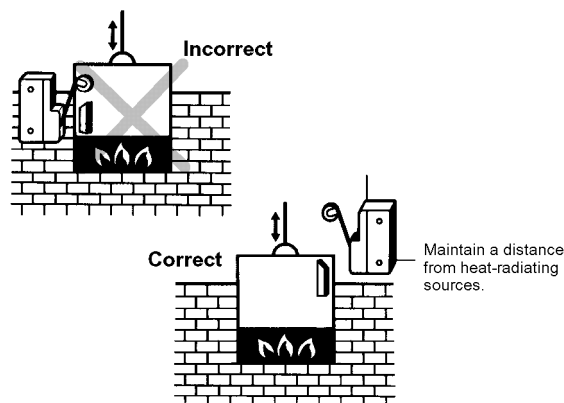

Storage Environment

When storing the Switch, consider countermeasures (e.g., storing in a plastic bag) to prevent discoloration resulting from sulfidization of terminals (silver-plated). Make sure that the location is free of corrosive gas or dust with no high temperature or humidity. It is recommended that the Switch be inspected before use if it is stored for three months or more.

Other Issues

Handling

Do not modify the switch in any way, for example, by expanding the mounting holes. Do not drop the Switch, otherwise the Switch may break or deform. Do not apply oil, grease, or other lubricants to the sliding parts of the Switch, otherwise the actuator may not operate smoothly. Furthermore, the intrusion of oil, grease, or other lubricants into the internal part may cause the Switch to fail.

Switch Trouble and Corrective Action

Type	Location of failure	Failure	Possible cause	Remedy
Failures related to electrical characteristics	Contacts	Contact failure	Dust and dirt collect on the contacts	Clean the environment, place the contact Switch in a box, or use a sealed Switch.
			Oil, water or other liquid has penetrated into the Switch.	
			Chemical substances have been generated on the contact surfaces because the atmosphere contains chemical gas.	Use a Switch having contacts with high environmental resistivity (such as gold or alloy contacts).
			Chemical substances have been generated on the contact surface when the Switch breaks a very low load.	
			Solder flux has penetrated into the Switch.	Review the soldering method or use a sealed or flux-tight Switch.
			Silicon gas exists near the switch	Remove the material generating gas, or adjust contact capacity to prevent formation of silicon compounds on the contacts.
		Malfunction	The contacts are separated from each other by vibration or shock.	Use a Switch having a high contact force (generally a heavy OF).
		Contact weld	The load connected to the Switch is too large.	Use a Switch having higher switching capacity, insert a relay to switch the heavy load or insert a contact protection circuit.
		Insulation degradation	Contacts have been melted and scattered by arc.	Insert a contact protection circuit or switch the load with a high-capacity relay or magnetic relay.
			Water has penetrated into the Switch because the Switch is placed in extremely humid environment.	Change the environment, place the Switch in a sealed box, or use a sealed Switch.
Oil or liquid has penetrated into the Switch and been carbonized by arc heat.				
Failures related to mechanical characteristics	Actuator	Operating failure	The sliding part of the actuator has been damaged because an excessive force was applied on the actuator.	Make sure that no excessive force is applied to the actuator, or use an auxiliary actuator mechanically strong.
			Foreign material, such as dust, dirt or oil, have penetrated into the switch,	Clean the environment or place the Switch in a sealed box.
			The actuator does not release because the operating body is too heavy.	Use a Switch having a larger OF.
			The Switch is loosely installed and thus does not operate even when the actuator is at the rated OP.	Secure the Switch.
		Service life is too short	The shape of the dog or cam is improper.	Change the design of the dog or cam.
			The operating method is improper.	Review the operating stroke and operating speed.
			Damage	A shock has been applied to the actuator.
		The clamping part has not been tightened enough or the Switch has been loosely mounted.		Replace the Switch with a new one.
		Deformation or drop-out. (Actuator was subjected to an excessive force or force from an inappropriate direction.		Relocate the Switch so that improper force will not be imposed on the actuator or in the wrong direction. Review the operating method.
		Mounting section	Damage	Screws have not been inserted straight.
	The mounting screws were tightened with too much torque.			Tighten the screws to an appropriate torque.
	The mounting pitch is wrong.			Correct the pitch.
	The Switch is not installed on a flat surface.			Install the Switch on a flat surface.
	Terminal	Damage	An excessive force was applied to the terminal while being wired.	Do not apply an excessive force.
			The plastic part has been deformed by solder heat	Use a soldering iron rated at a lower wattage.

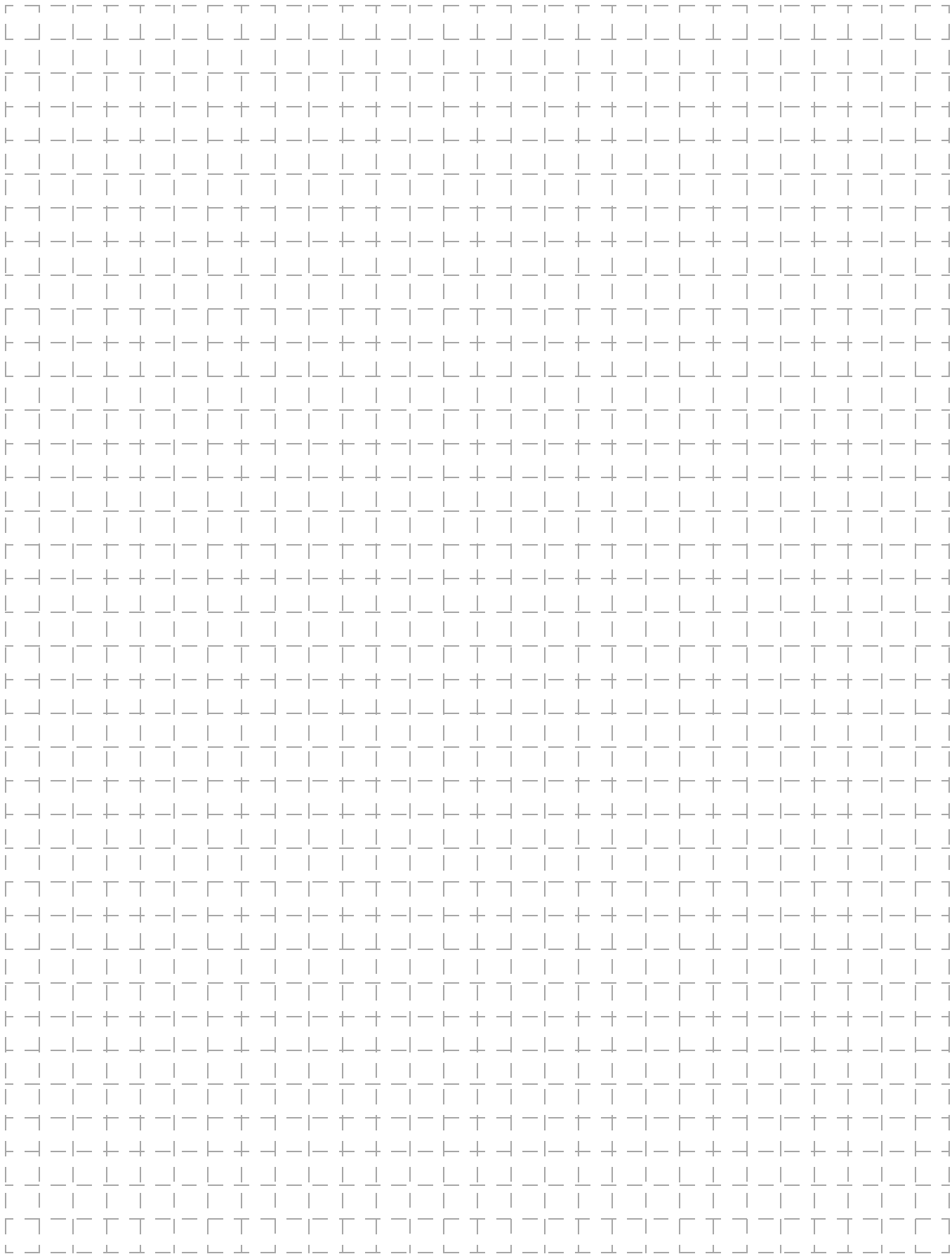

All sales are subject to Omron Electronic Components LLC standard terms and conditions of sale, which can be found at http://www.components.omron.com/components/web/webfiles.nsf/sales_terms.html

ALL DIMENSIONS SHOWN ARE IN MILLIMETERS.

To convert millimeters into inches, multiply by 0.03937. To convert grams into ounces, multiply by 0.03527.

OMRON[®]

**OMRON ELECTRONIC
COMPONENTS LLC**

55 E. Commerce Drive, Suite B
Schaumburg, IL 60173

847-882-2288

OMRON ON-LINE

Global - <http://www.omron.com>

USA - <http://www.components.omron.com>